

Solo com capacidade de suporte > 1.60 kgf/cm²
Solo compactado sobre a sapata
peso específico > 1600.00 kgf/m³

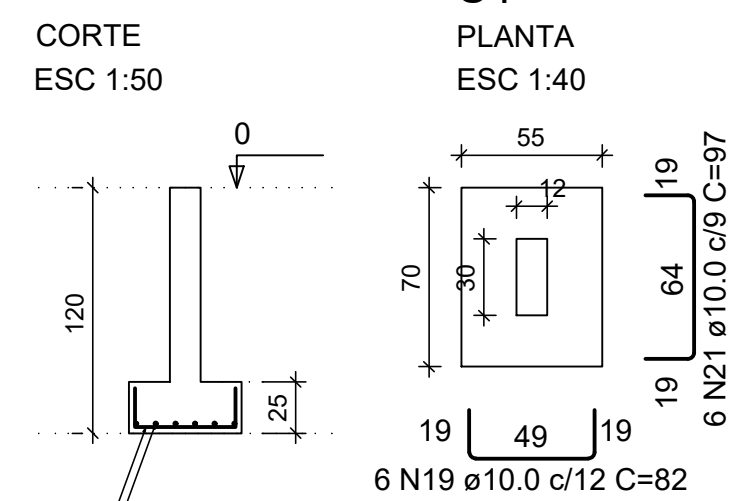

Solo com capacidade de suporte > 1.60 kgf/cm²
Solo compactado sobre a sapata
peso específico > 1600.00 kgf/m³

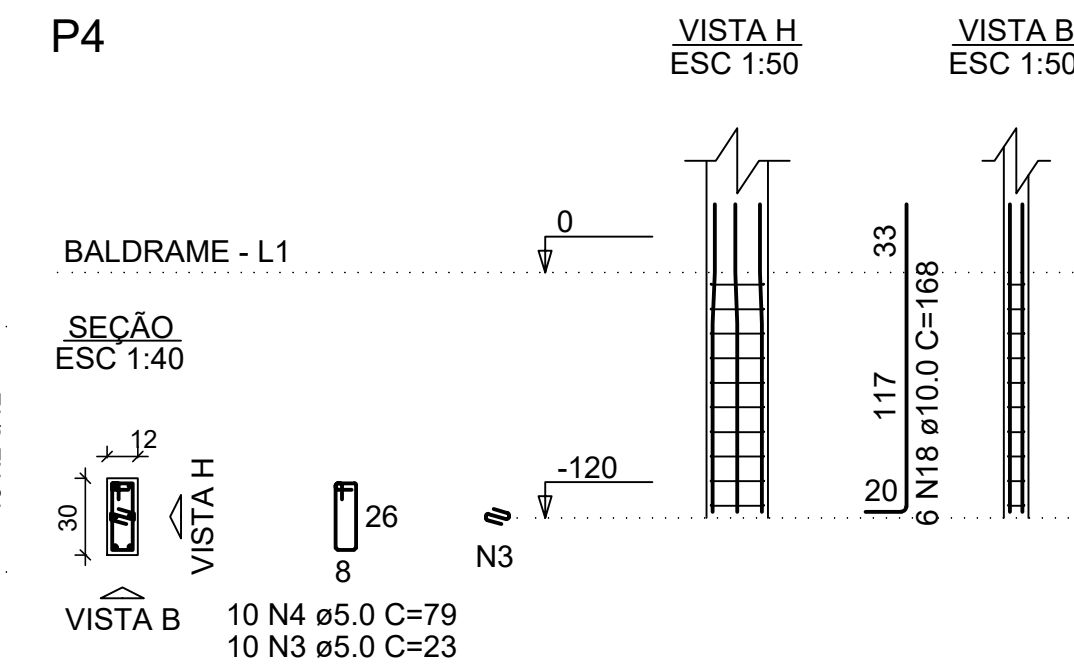
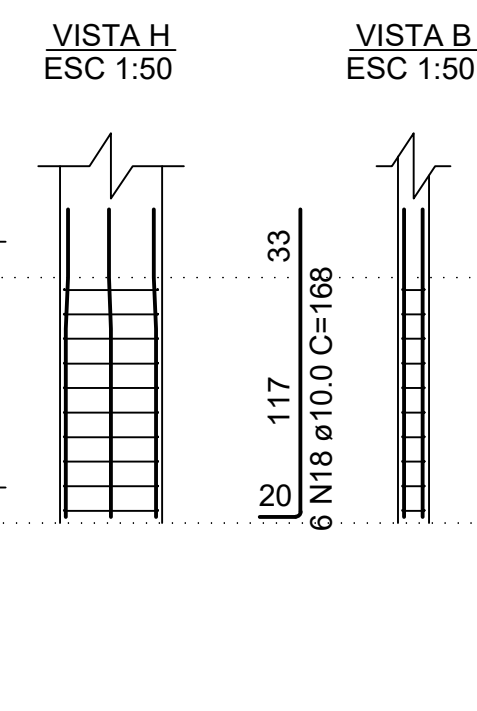
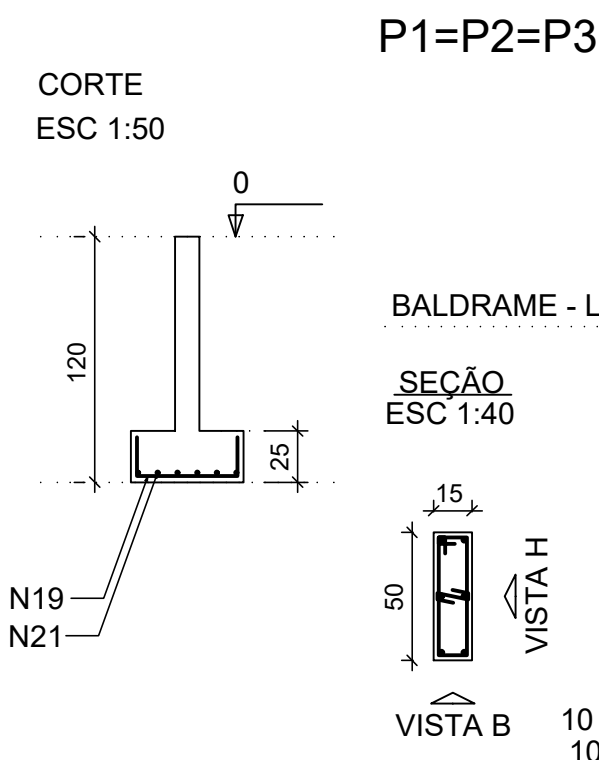

RELAÇÃO DO AÇO

AÇO N	DIAM (mm)	QUANT (cm)	UNIT (cm)	C.TOTAL (cm)
CA60	1	5.0	99	26
	2	5.0	99	125
	3	5.0	33	23
	4	5.0	106	79
	5	5.0	88	69
CA50	6	8.0	2	360
	7	8.0	2	352
	8	8.0	2	336
	9	8.0	2	359
	10	8.0	6	351
	11	8.0	2	335
	12	8.0	2	366
	13	8.0	2	363
	14	8.0	1	205
	15	8.0	1	75
	16	8.0	1	76
	17	10.0	24	263
	18	10.0	24	168
	19	10.0	24	82
	20	10.0	18	117
	21	10.0	6	97
	22	10.0	6	351
	23	10.0	2	350
	24	10.0	2	362
	25	10.0	2	385

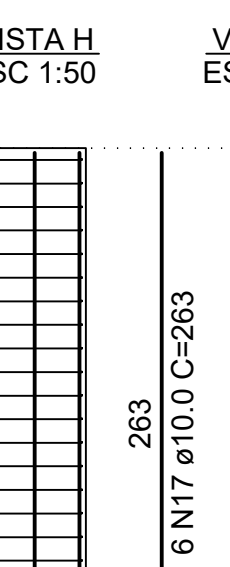
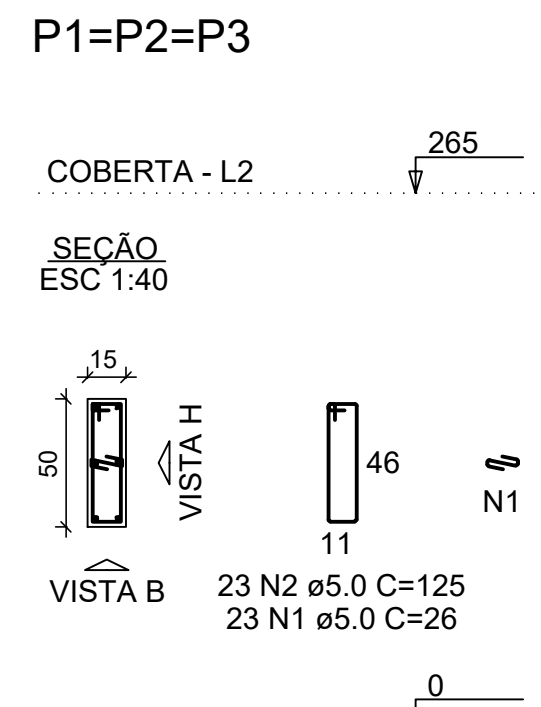
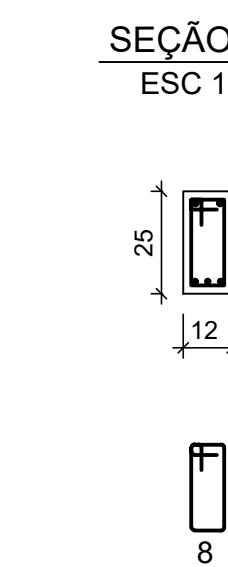
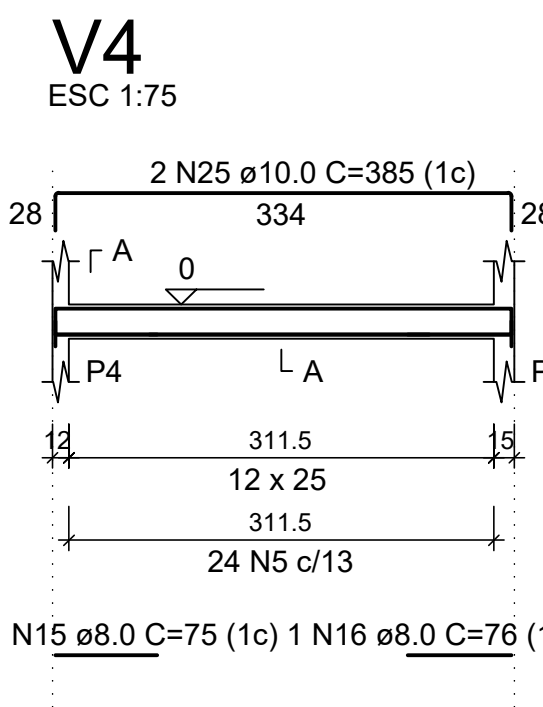
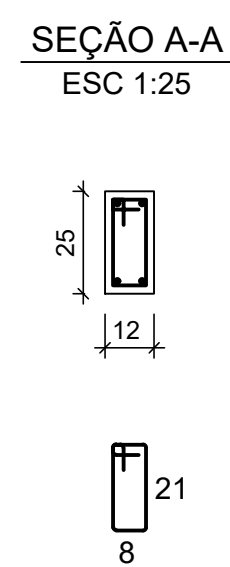
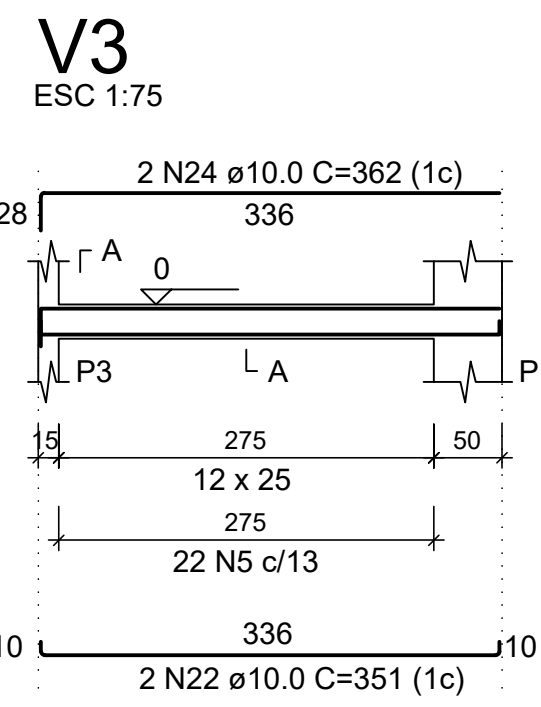
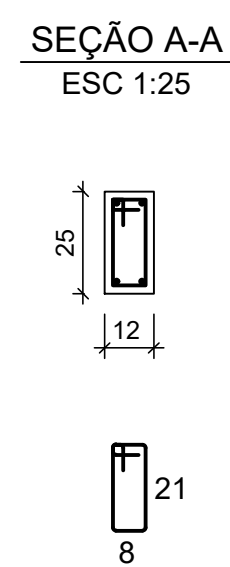
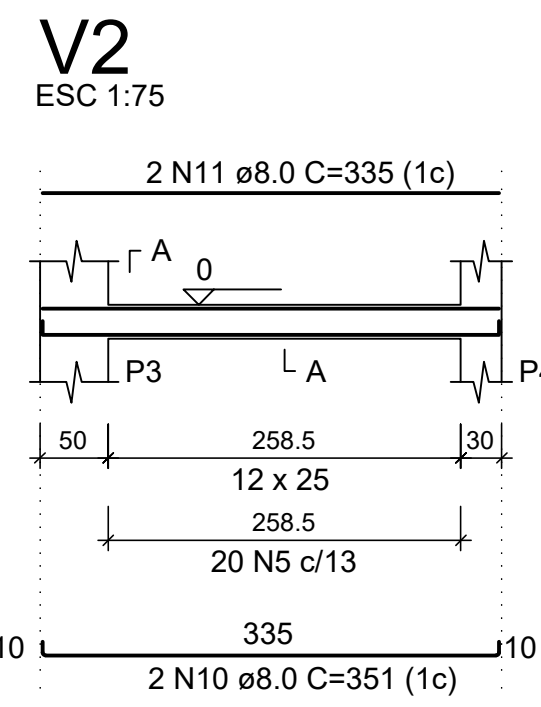
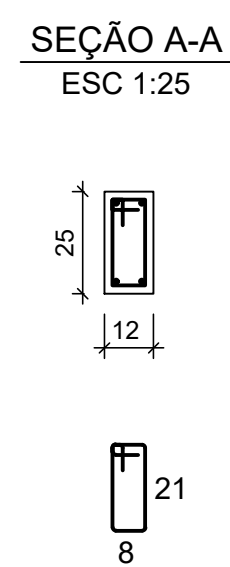
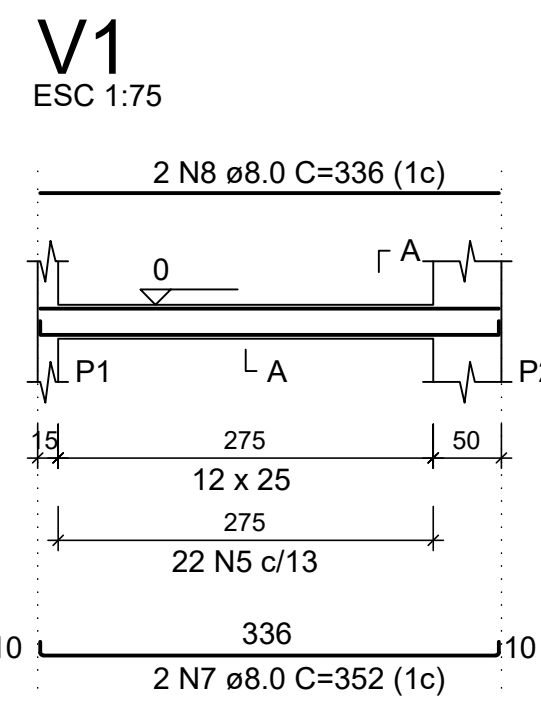

RESUMO DO AÇO

AÇO	DIAM (mm)	C.TOTAL (m)	QUANT + 10% (Barras)	PESO + 10% (kg)
CA50	8.0	74	7	32.1
CA60	10.0	193	18	130.9
CA60	5.0	301.5	28	51.1
PESO TOTAL (kg)				
CA50				163
CA60				51.1

Volume de concreto (C-30) = 2.88 m³
Área de forma = 39.23 m²

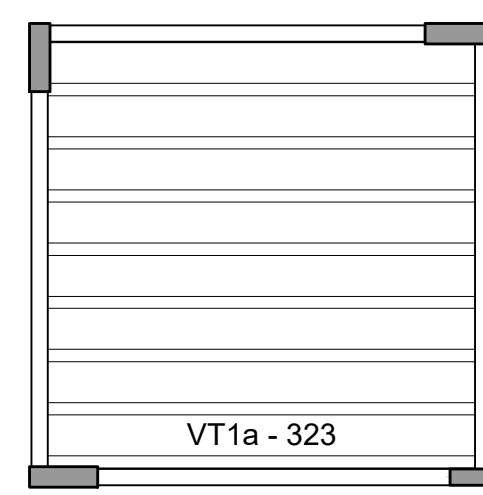
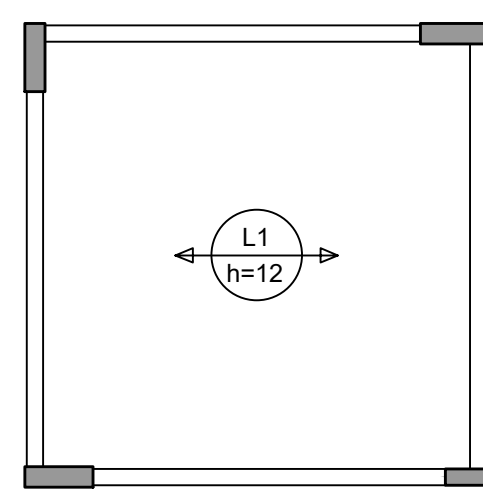
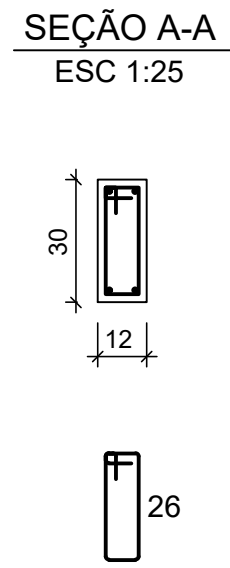
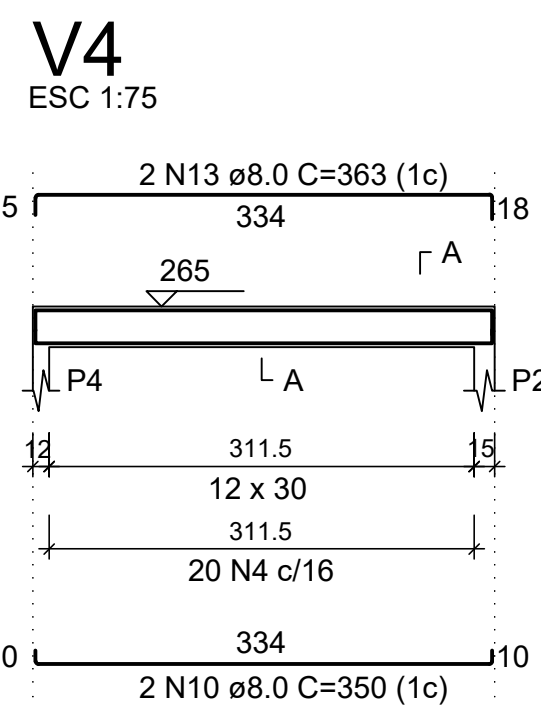
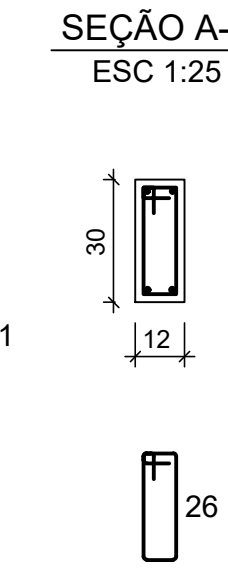
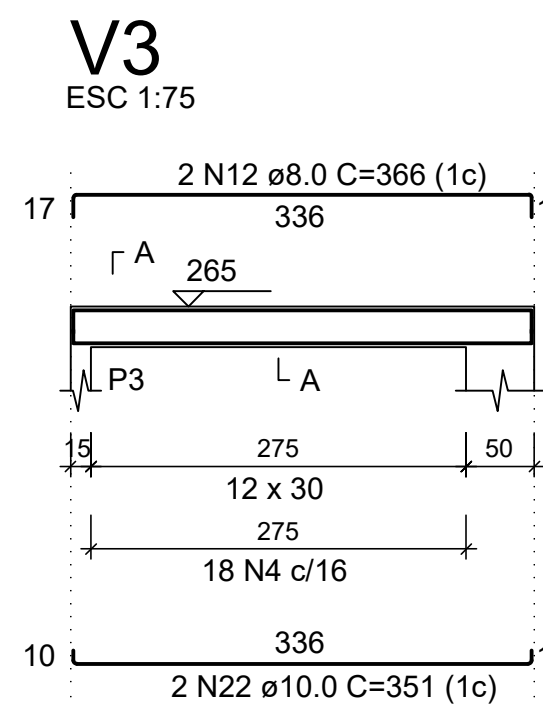
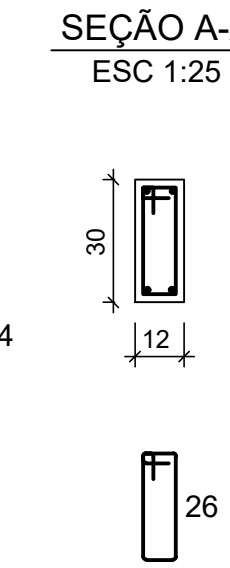
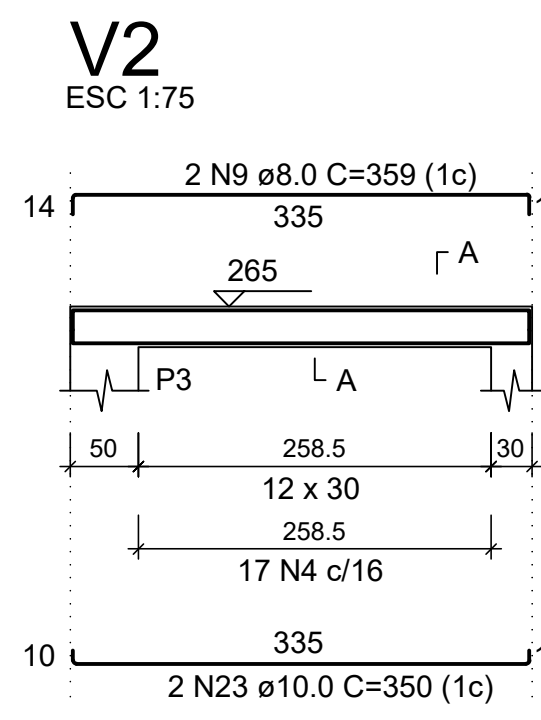
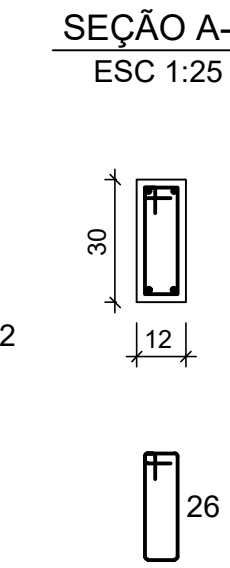
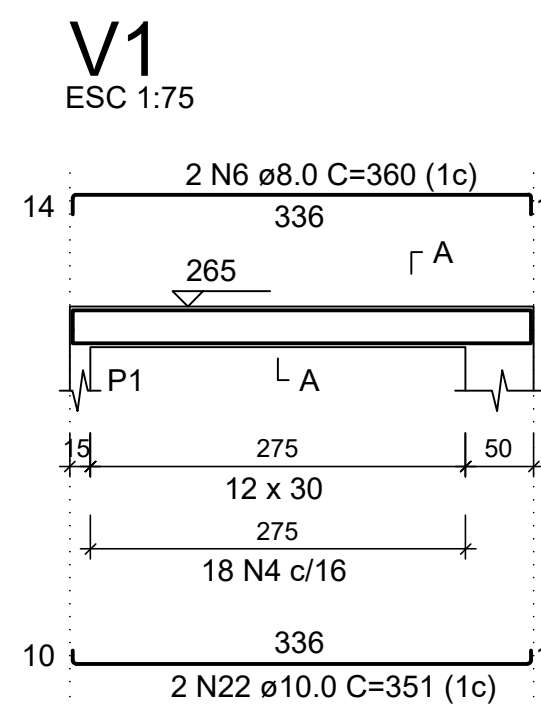
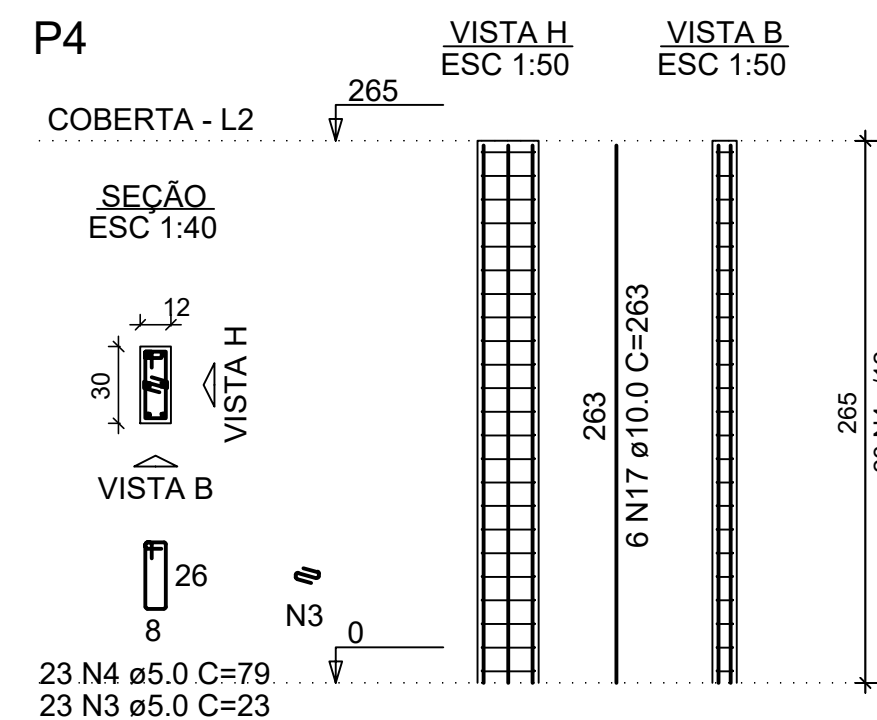

Armação positiva das lajes do pavimento Coberta Planta de vigotas pré-moldadas

escala 1:75

escala 1:75

FERRAGEM ADICIONAL DAS VIGOTAS (TRELIÇAS)

VT1a (8 unidades)
(L1)
ESC 1:75

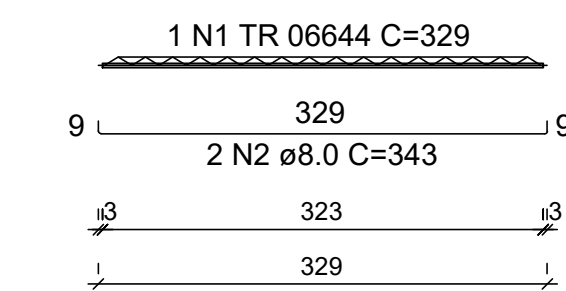

RELAÇÃO DO AÇO

AÇO N	DIAM (mm)	QUANT	C.UNIT (cm)	C.TOTAL (cm)
CA60	1	TR 06644	8	329
CA50	2	8.0	16	343

RESUMO DO AÇO

AÇO	DIAM (mm)	C.TOTAL (m)	QUANT + 10% (Barras)	PESO + 10% (kg)
CA50	8.0	54.9	6	23.8
CA60 TR 06644		26.3	-	20.6
PESO TOTAL (kg)				
CA50				23.8
CA60				20.6

Volume de concreto (C-30) = 0.00 m³
Área de forma = 0.00 m²

Endereço: Praça dos Três Poderes, Número 141 - Centro, Petrolândia - PE - CEP 54640-000
Tel. (87) 3851-1156
CNPJ: 10.106.235/0001-16

SERVIÇO: CABINE DE PESAGEM BALANÇA RODOVIÁRIA
LOCAL: AVENIDA DJALMA WANDERLEY, PETROLÂNDIA/PE

DESENHISTA: BERNARDO SILVA
RESPONSÁVEL TÉCNICO:
ÁREAS: Construída: 9,49 m²
DATA: Setembro 22

CONTEÚDO: ESTRUTURAL - CORTES E DETALHES

ESCALA: INDICADA APROVAÇÃO: FOLHA: 02/04

ESTRUTURAL

PORTAL DA TRANSPARENCIA